

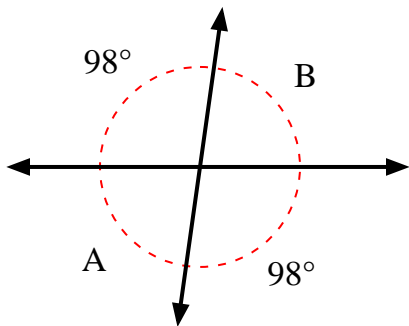

Encuentra el valor del ángulo 'A' y el ángulo 'B'.

1)



2)

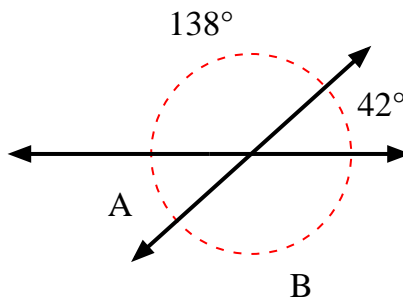

3)

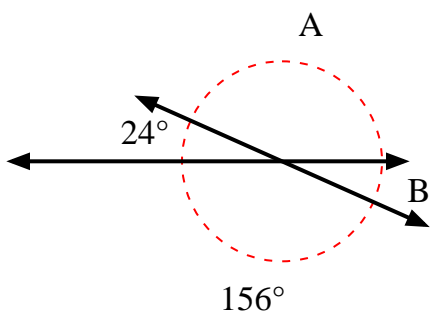

4)

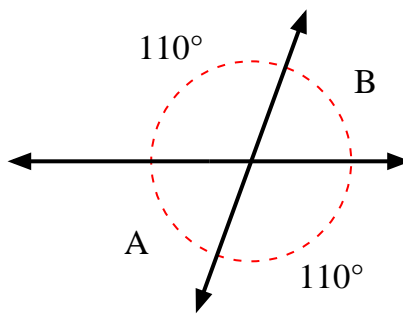

5)

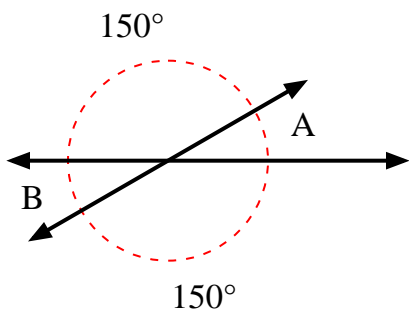

6)

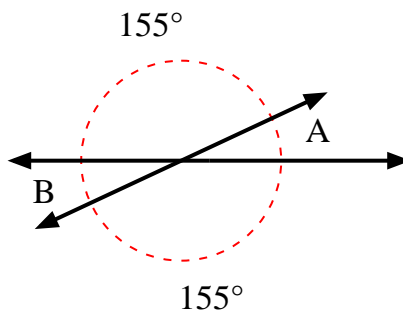

7)

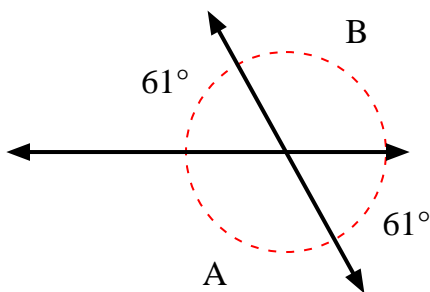

8)

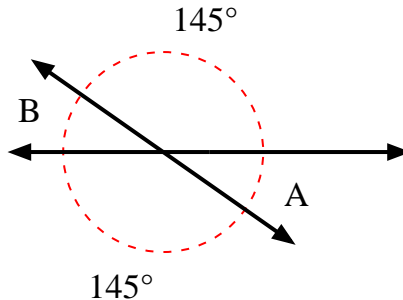

Respuestas

1. _____
2. _____
3. _____
4. _____
5. _____
6. _____
7. _____
8. _____



Encuentra el valor del ángulo 'A' y el ángulo 'B'.

1)

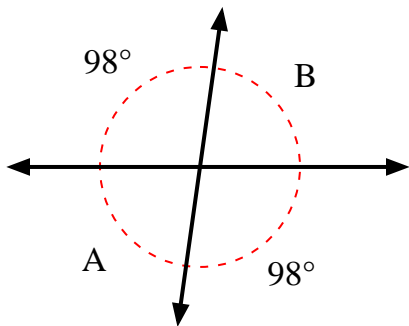

2)

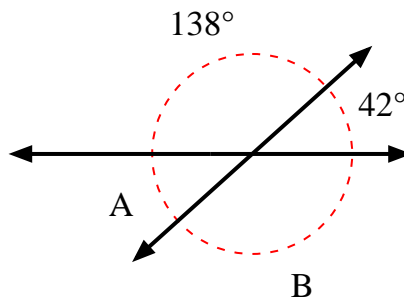

3)

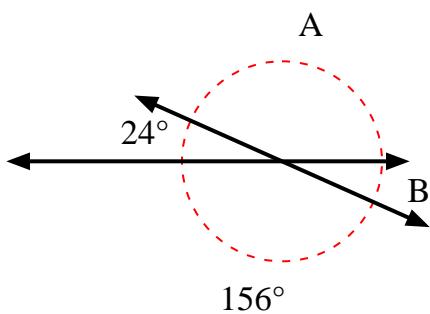

4)

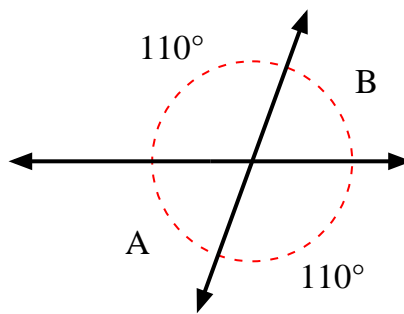

5)

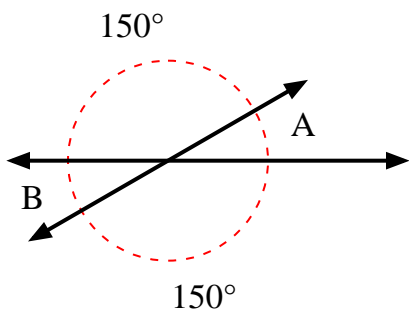

6)

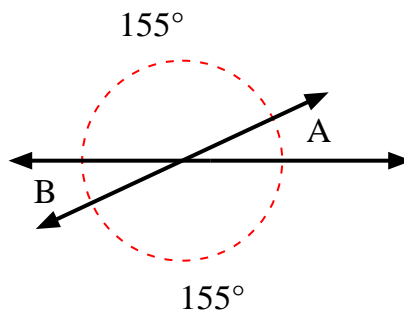

7)

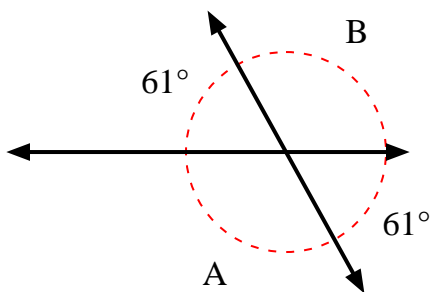

8)

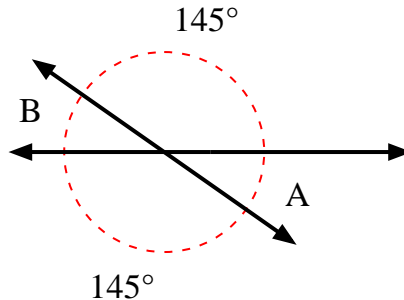

Respuestas

1.	82°	82°
2.	42°	138°
3.	156°	24°
4.	70°	70°
5.	30°	30°
6.	25°	25°
7.	119°	119°
8.	35°	35°