

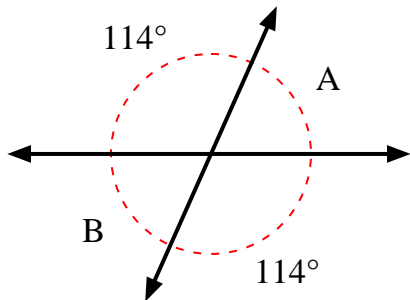

Encuentra el valor del ángulo 'A' y el ángulo 'B'.

1)



2)

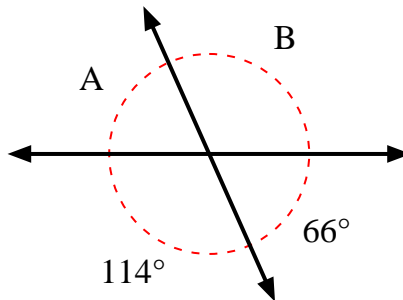

3)

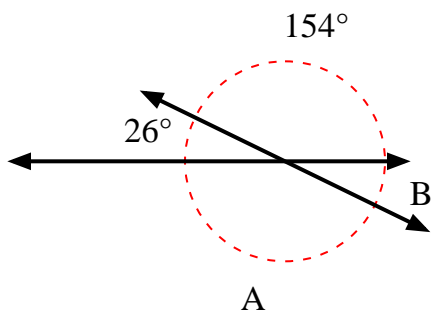

4)

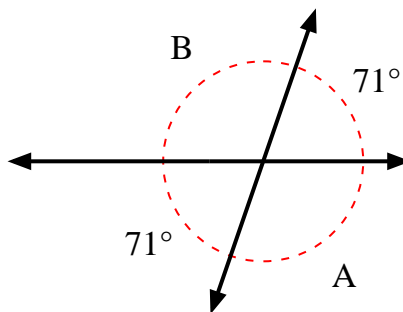

5)

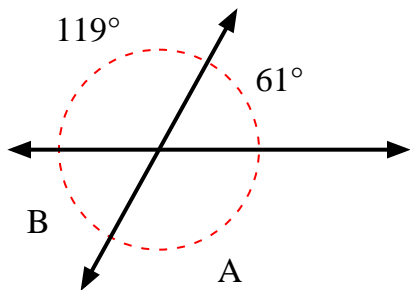

6)

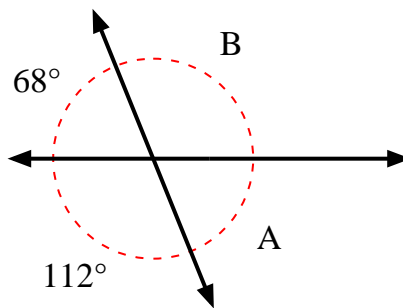

7)

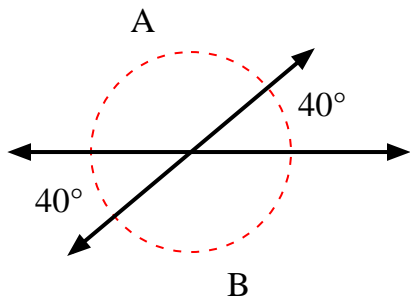

8)

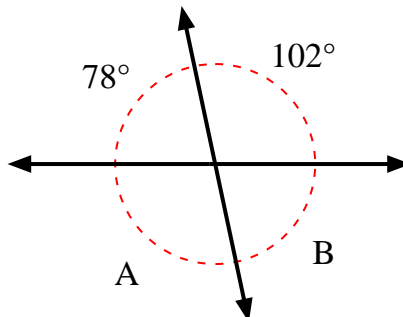

Respuestas

1. _____
2. _____
3. _____
4. _____
5. _____
6. _____
7. _____
8. _____



Encuentra el valor del ángulo 'A' y el ángulo 'B'.

1)

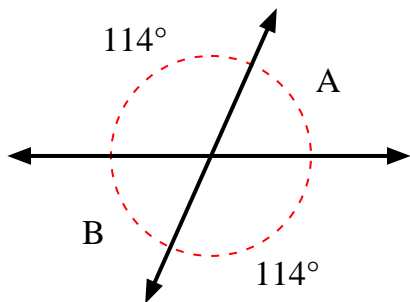

2)

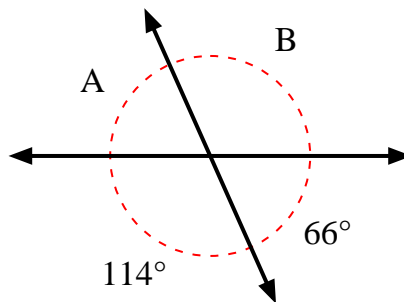

3)

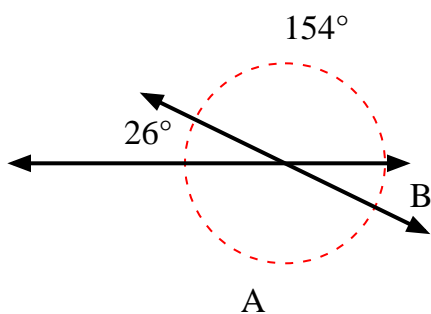

4)

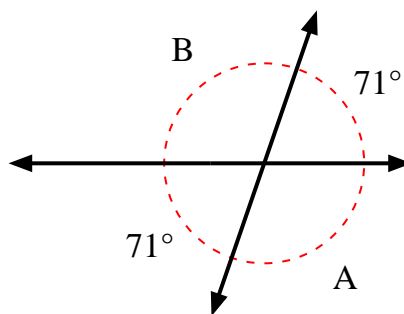

5)

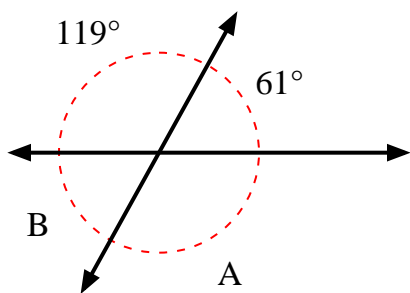

6)

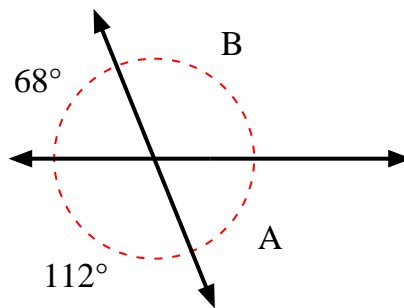

7)

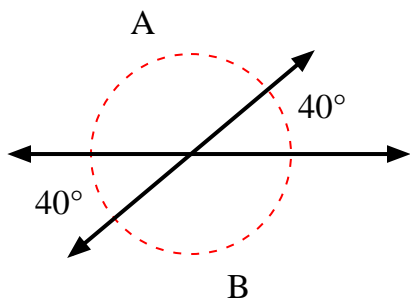

8)

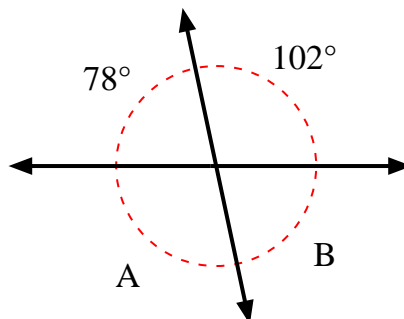

Respuestas

1.	66°	66°
2.	66°	114°
3.	154°	26°
4.	109°	109°
5.	119°	61°
6.	68°	112°
7.	140°	140°
8.	102°	78°