

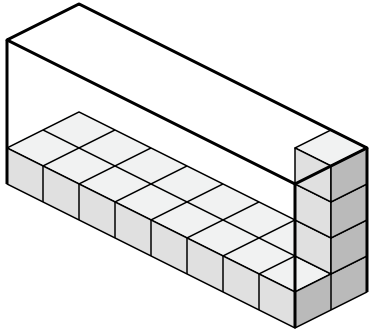

Cree una expresión para determinar el volumen de cada caja.

1)



2)

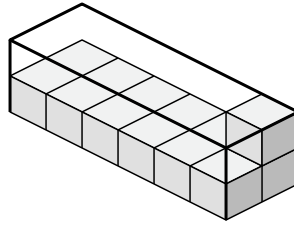

3)

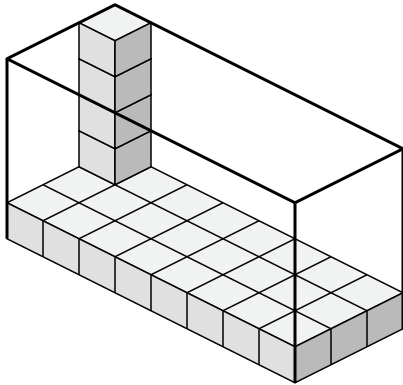

4)

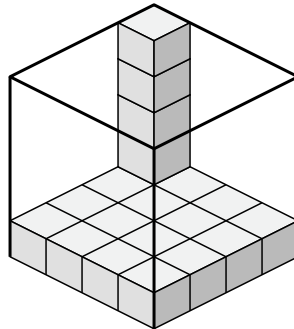

5)

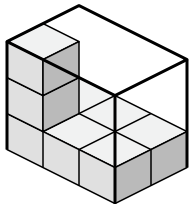

6)

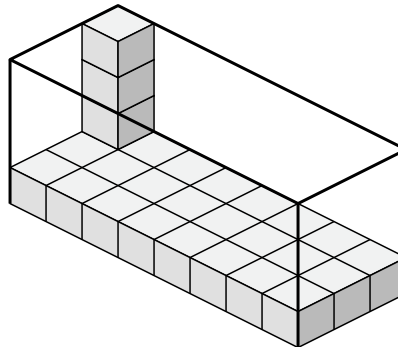

7)

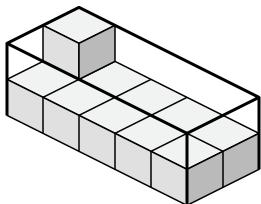

8)

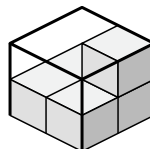

Respuestas

1. _____

2. _____

3. _____

4. _____

5. _____

6. _____

7. _____

8. _____



Cree una expresión para determinar el volumen de cada caja.

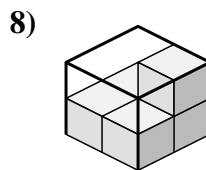
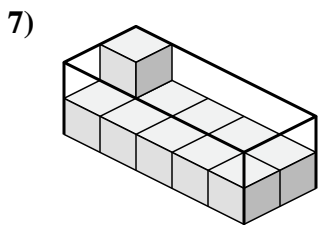
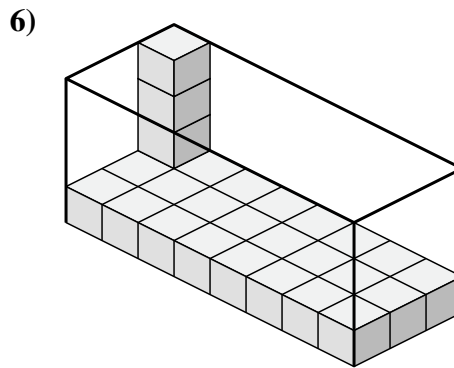
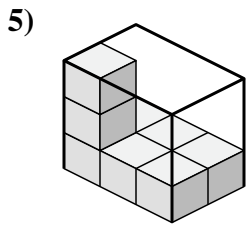
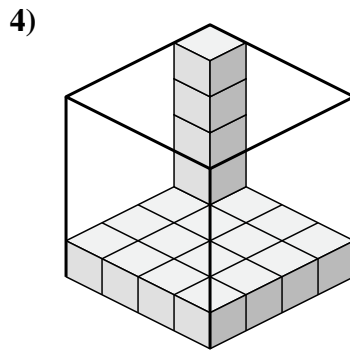
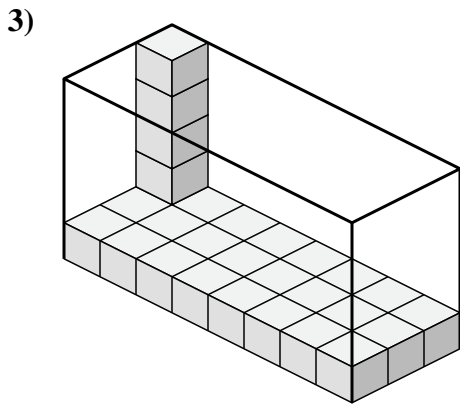
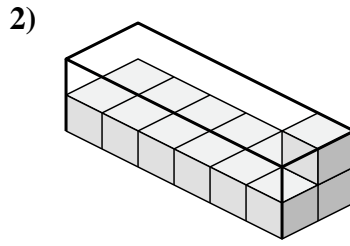
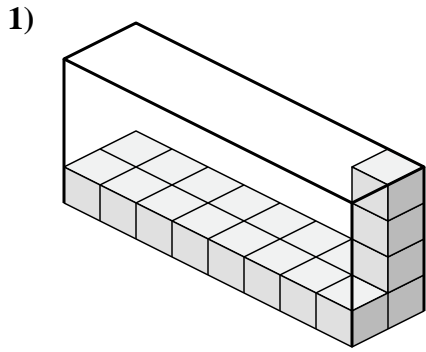

Respuestas

1. 8×2×4

2. 6×2×2

3. 8×3×5

4. 4×4×5

5. 3×2×3

6. 8×3×4

7. 5×2×2

8. 2×2×2