

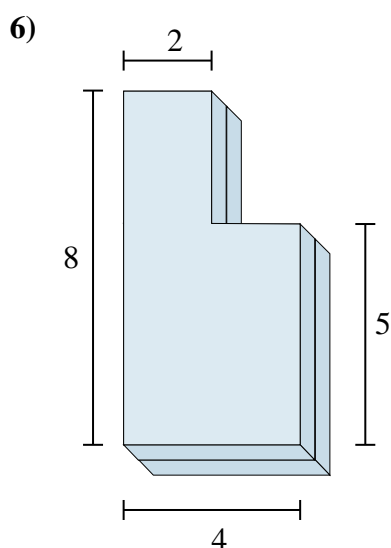

Encontrar el valor total de cada figura mostrada.

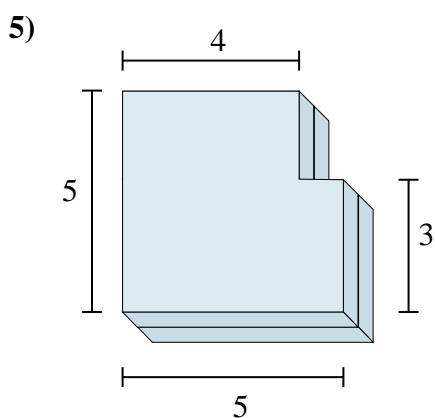
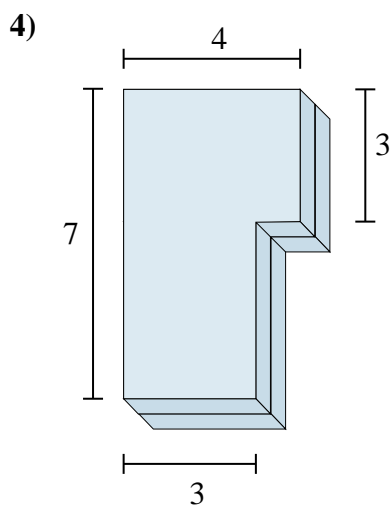
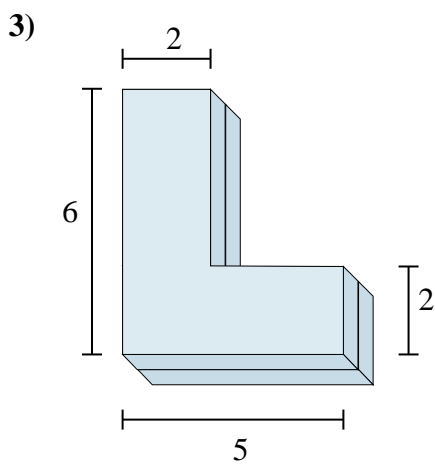
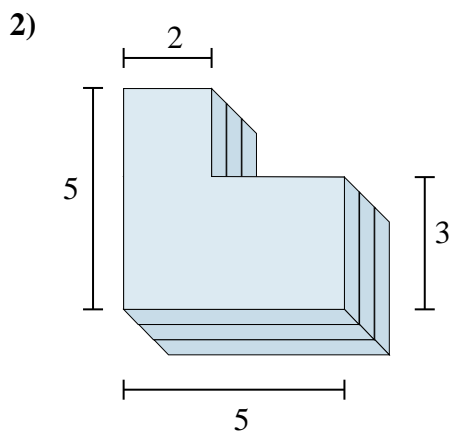
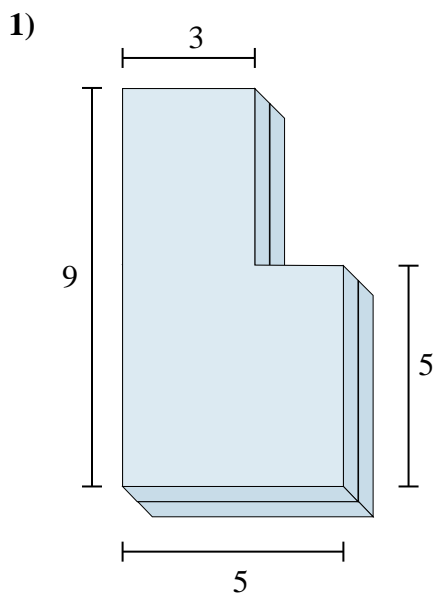

Respuestas

1. _____

2. _____

3. _____

4. _____

5. _____

6. _____



Encontrar el valor total de cada figura mostrada.

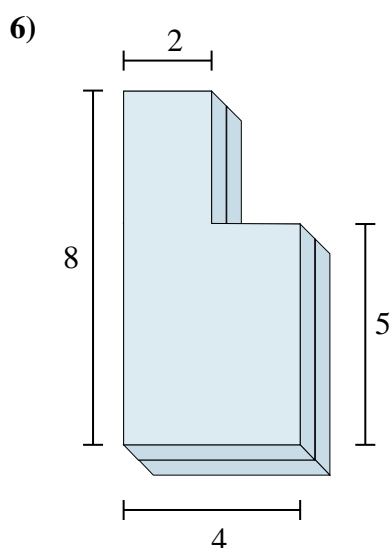
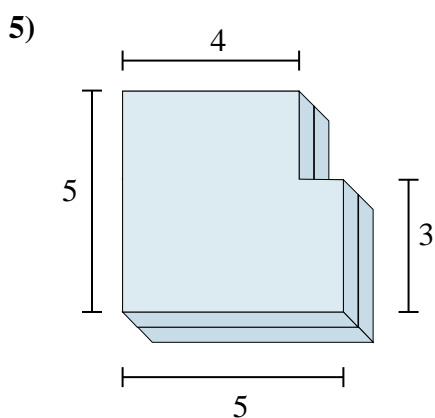
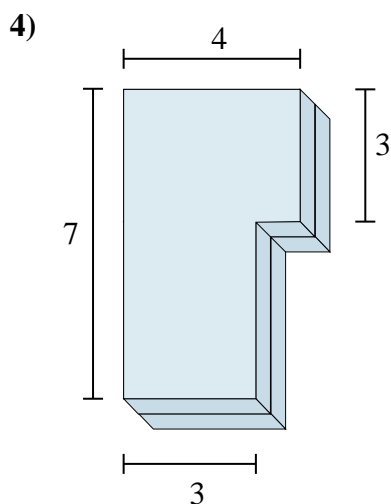
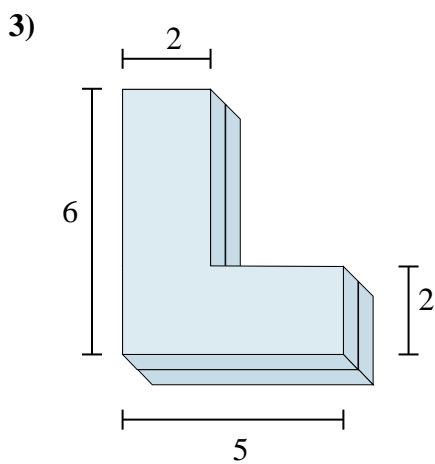
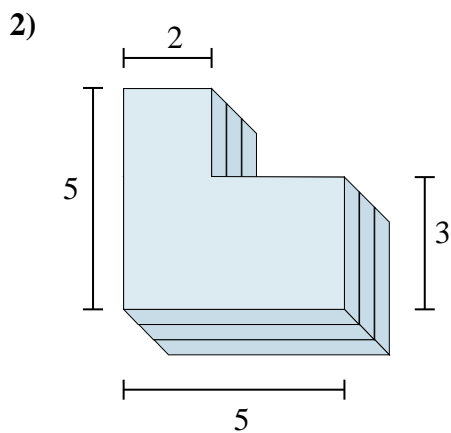
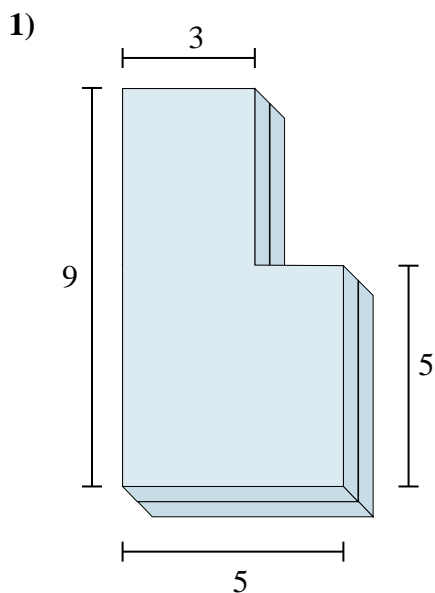

Respuestas

1. 74 cm³

2. 57 cm³

3. 36 cm³

4. 48 cm³

5. 46 cm³

6. 52 cm³



Encontrar el valor total de cada figura mostrada.

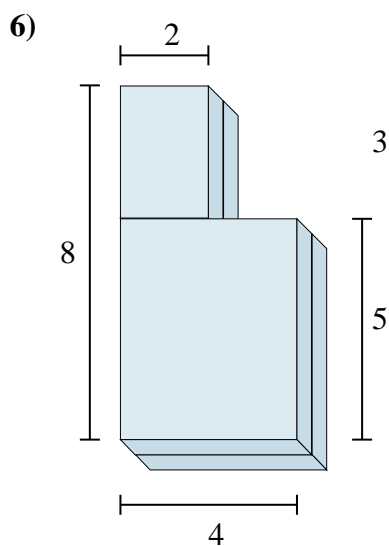
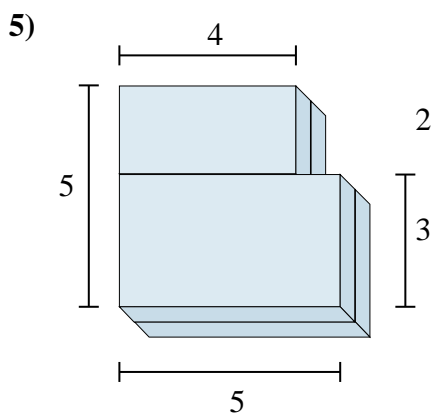
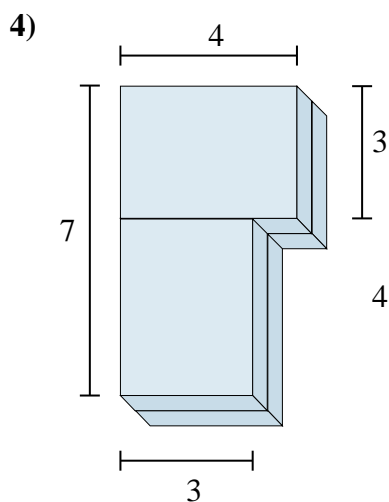
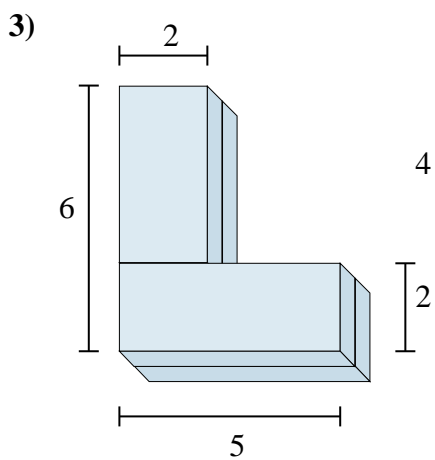
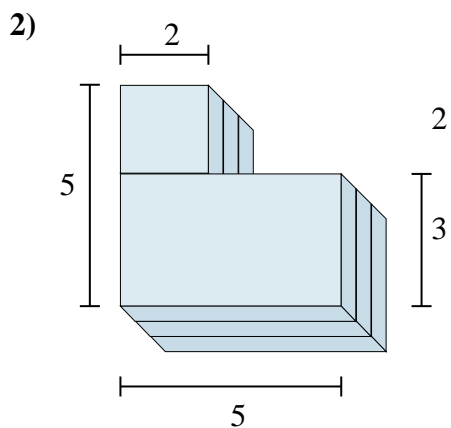
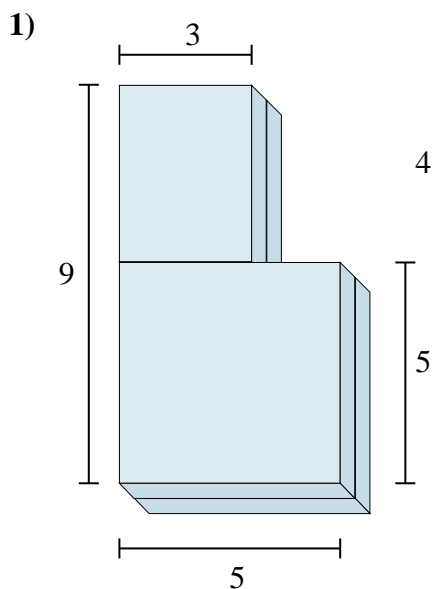

Respuestas

1. _____
2. _____
3. _____
4. _____
5. _____
6. _____