

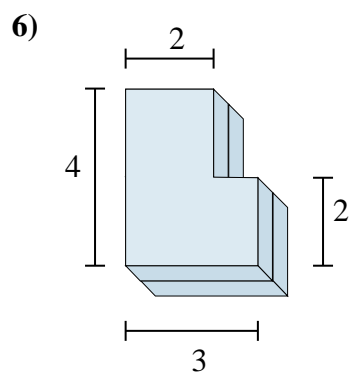

Encontrar el valor total de cada figura mostrada.

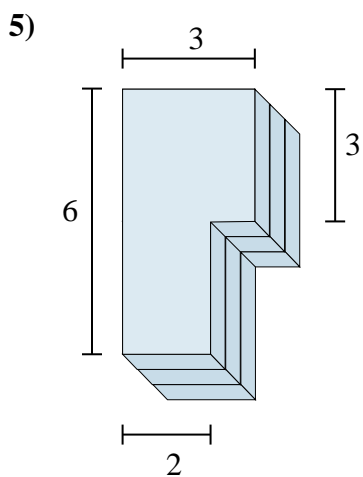
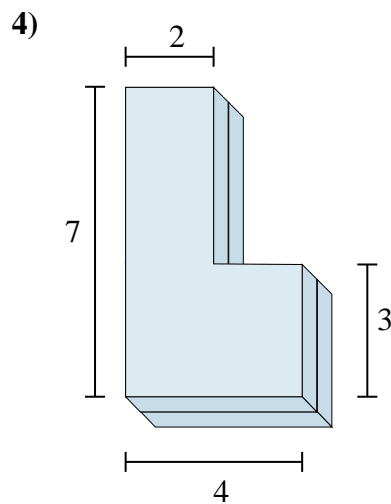
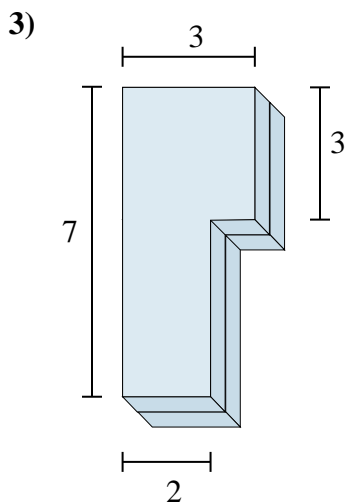
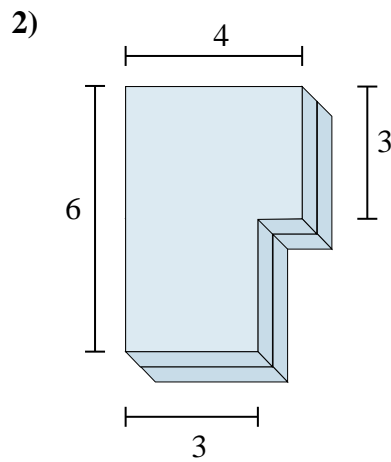
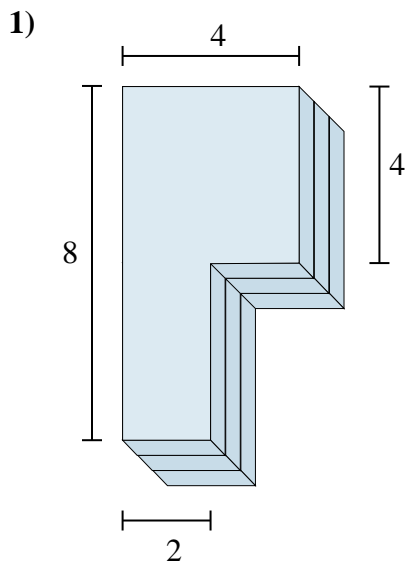

**Respuestas**

- 1. \_\_\_\_\_
- 2. \_\_\_\_\_
- 3. \_\_\_\_\_
- 4. \_\_\_\_\_
- 5. \_\_\_\_\_
- 6. \_\_\_\_\_



Encontrar el valor total de cada figura mostrada.

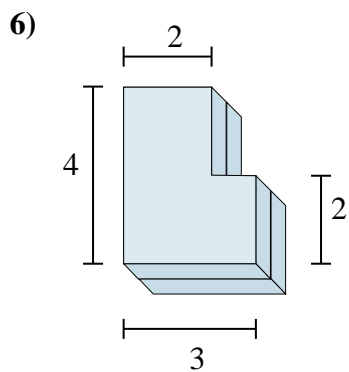
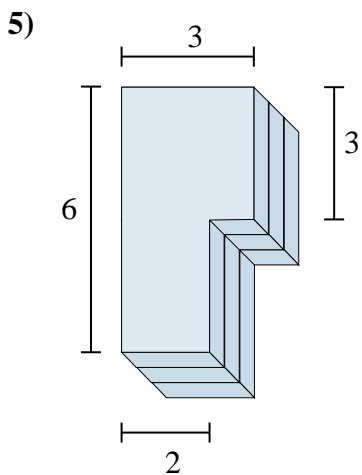
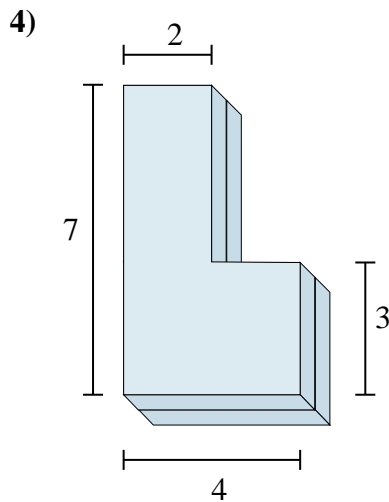
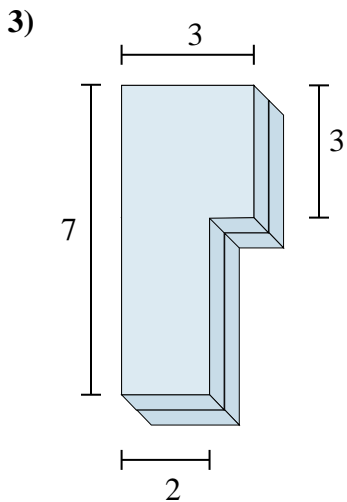
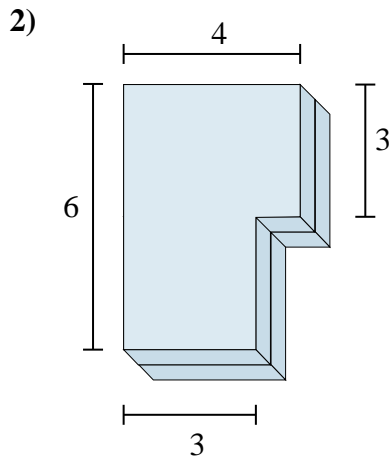
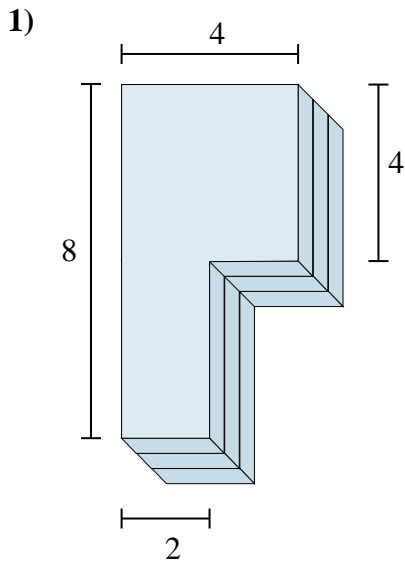

**Respuestas**

1. 72 cm<sup>3</sup>
2. 42 cm<sup>3</sup>
3. 34 cm<sup>3</sup>
4. 40 cm<sup>3</sup>
5. 45 cm<sup>3</sup>
6. 20 cm<sup>3</sup>



Encontrar el valor total de cada figura mostrada.

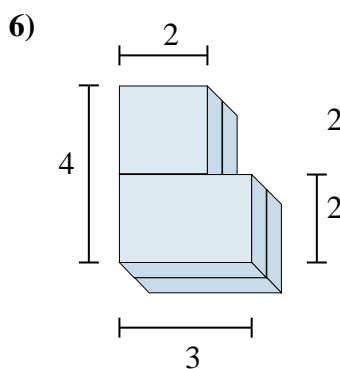
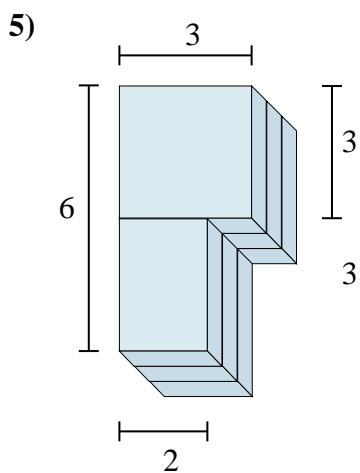
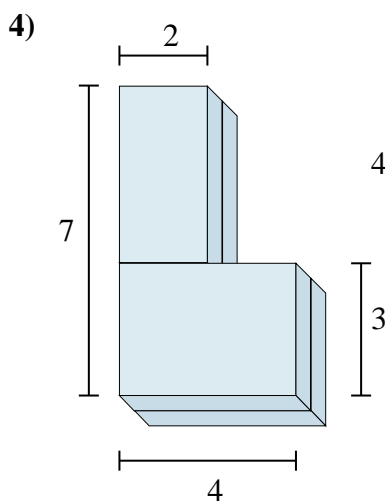
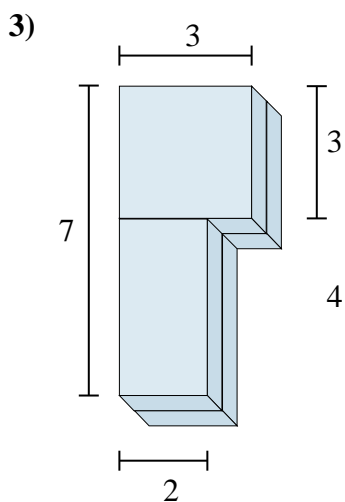
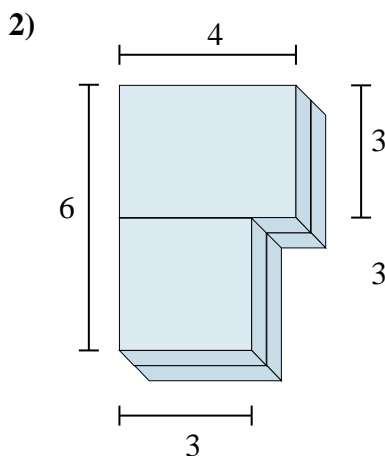
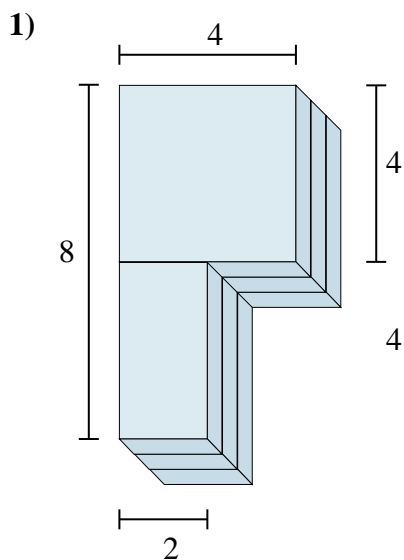

**Respuestas**

1. \_\_\_\_\_
2. \_\_\_\_\_
3. \_\_\_\_\_
4. \_\_\_\_\_
5. \_\_\_\_\_
6. \_\_\_\_\_