

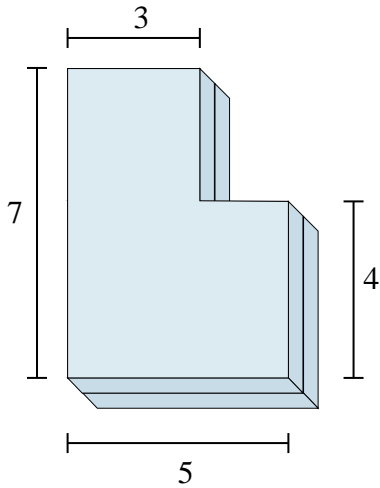

Encontrar el valor total de cada figura mostrada.

1)



2)

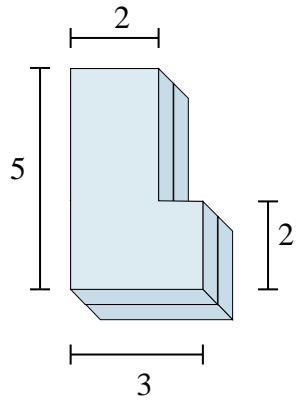

3)

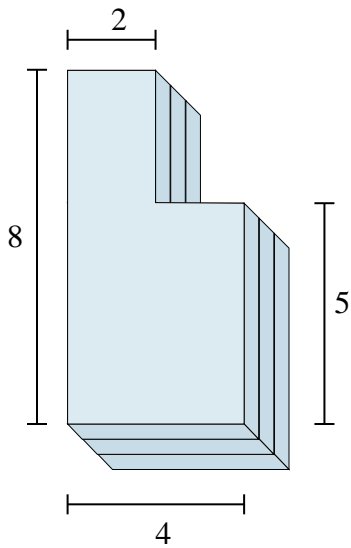

4)

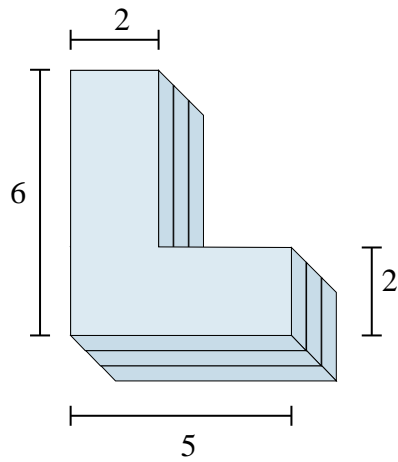

5)

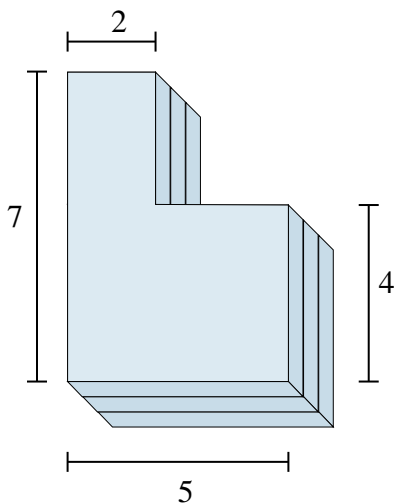

6)

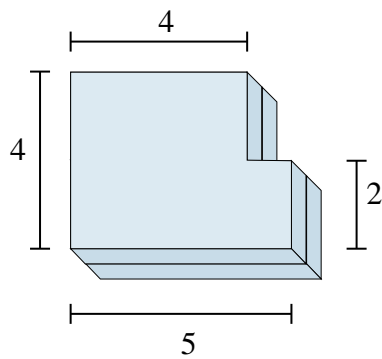

Respuestas

1. _____

2. _____

3. _____

4. _____

5. _____

6. _____



Encontrar el valor total de cada figura mostrada.

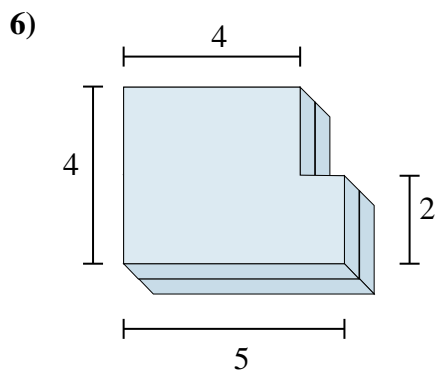
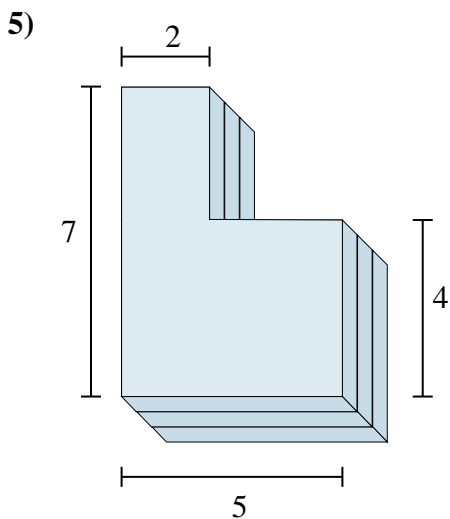
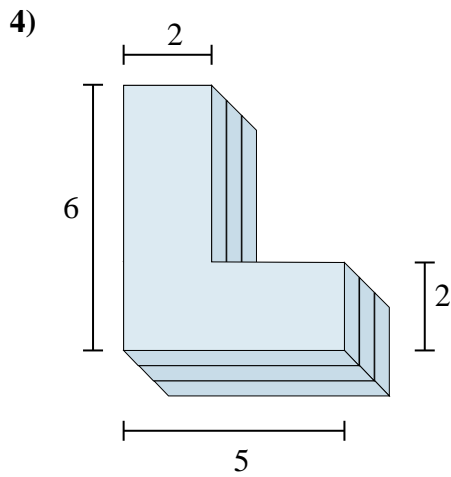
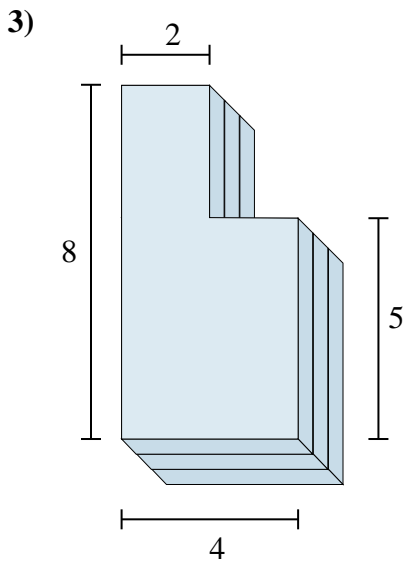
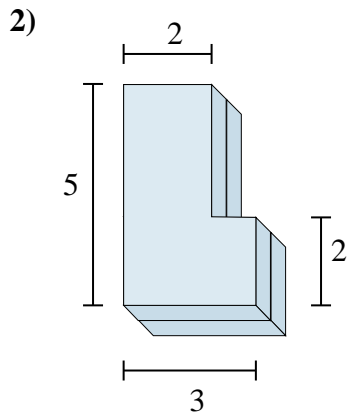
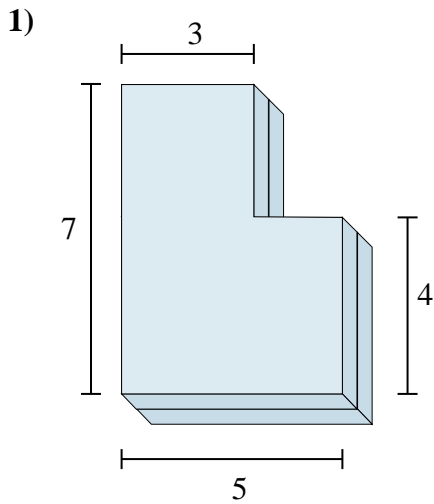

Respuestas

1. 58 cm³
2. 24 cm³
3. 78 cm³
4. 54 cm³
5. 78 cm³
6. 36 cm³



Encontrar el valor total de cada figura mostrada.

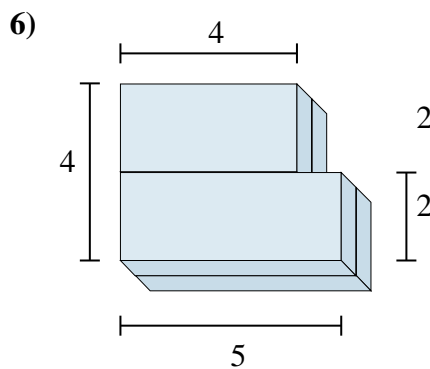
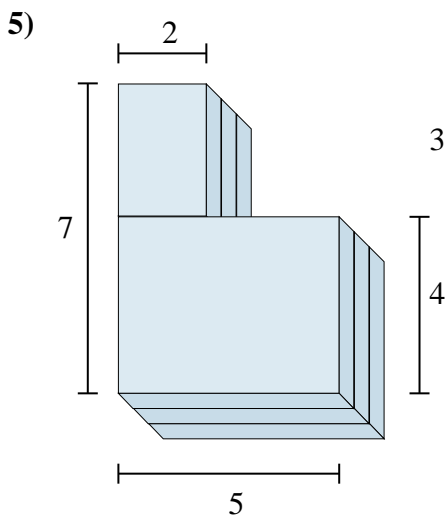
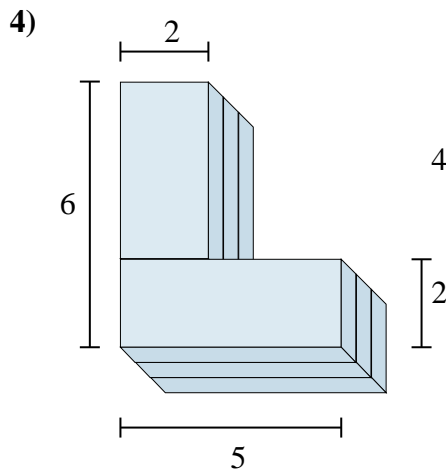
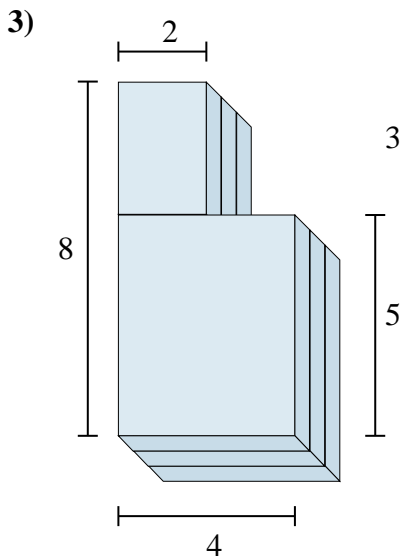
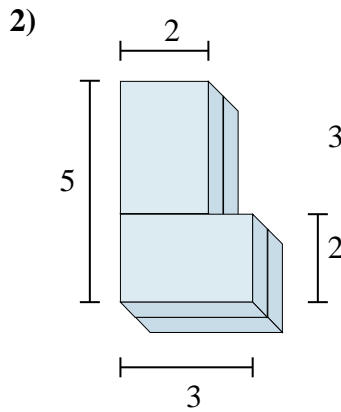
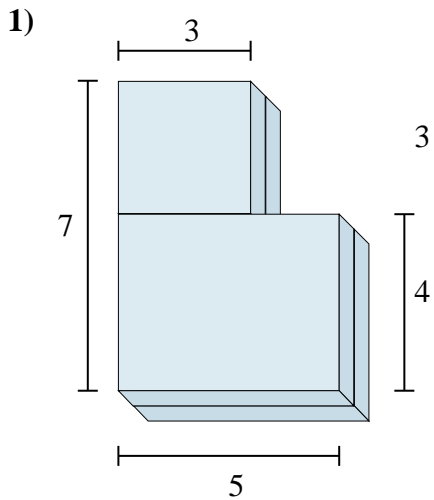

Respuestas

1. _____
2. _____
3. _____
4. _____
5. _____
6. _____