

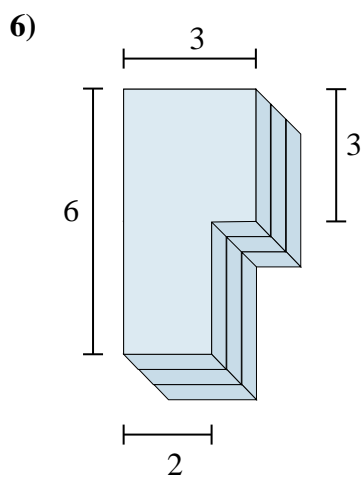

Encontrar el valor total de cada figura mostrada.

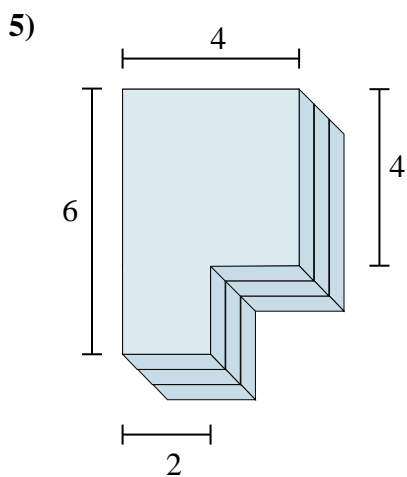
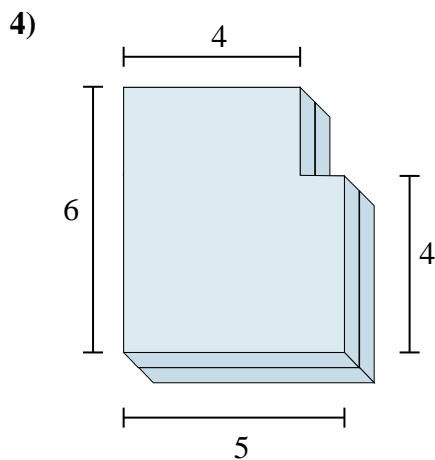
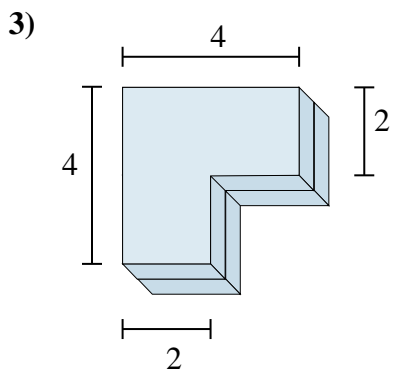
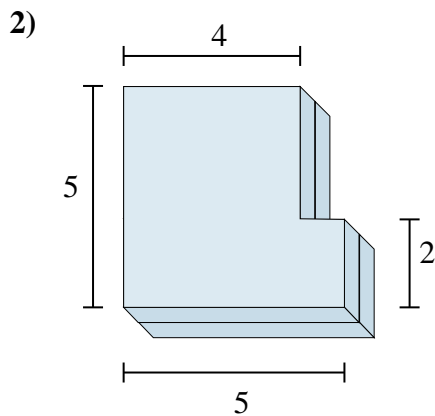
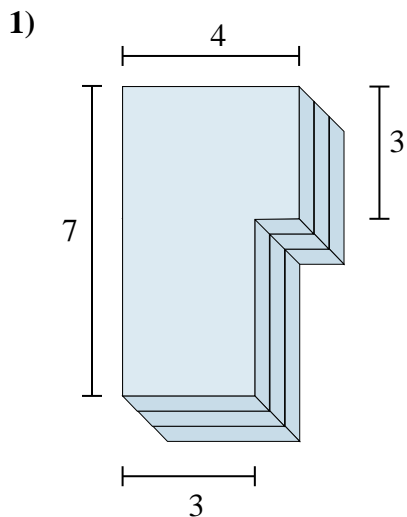

Respuestas

- 1. _____
- 2. _____
- 3. _____
- 4. _____
- 5. _____
- 6. _____



Encontrar el valor total de cada figura mostrada.

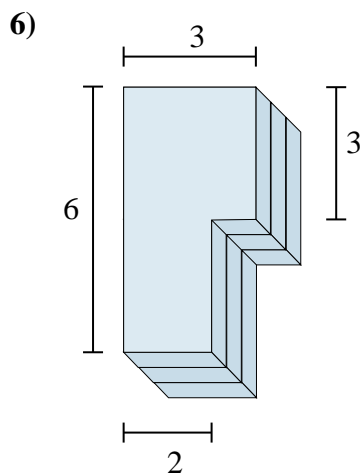
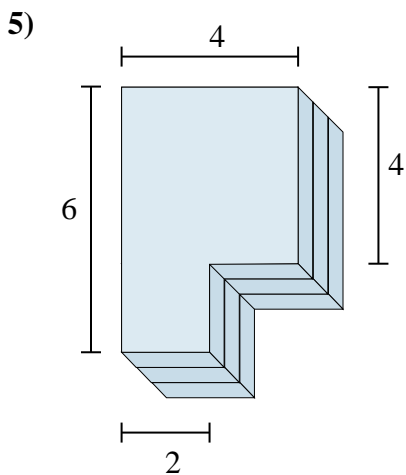
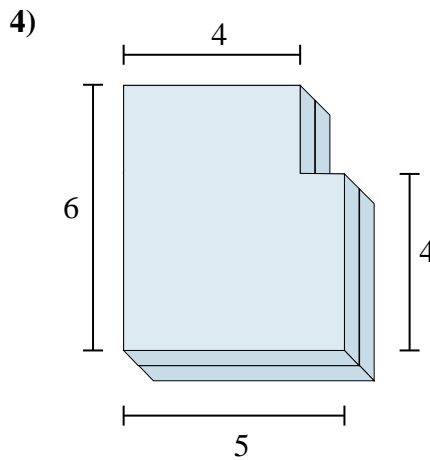
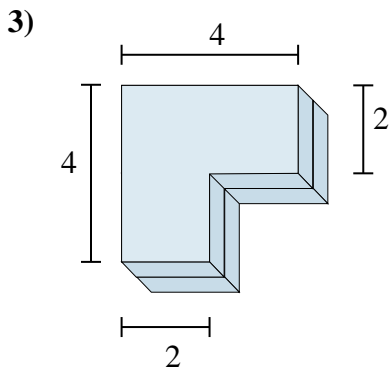
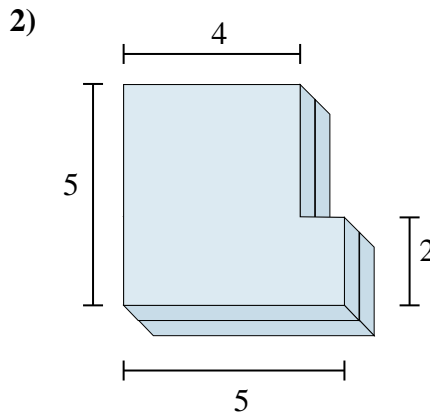
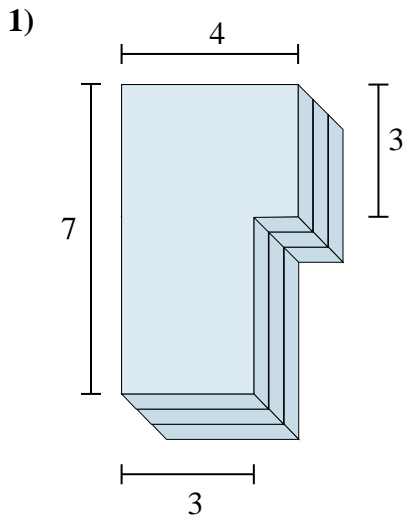

Respuestas

1. 72 cm³
2. 44 cm³
3. 24 cm³
4. 56 cm³
5. 60 cm³
6. 45 cm³



Encontrar el valor total de cada figura mostrada.

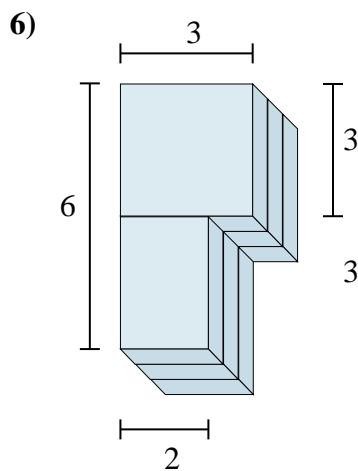
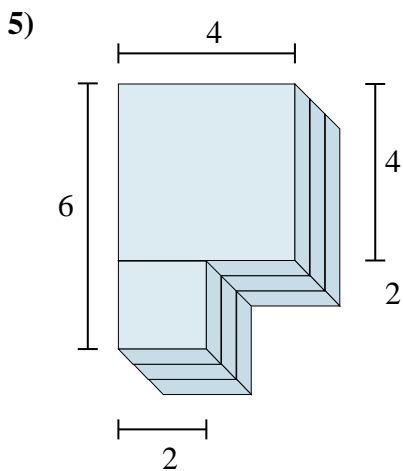
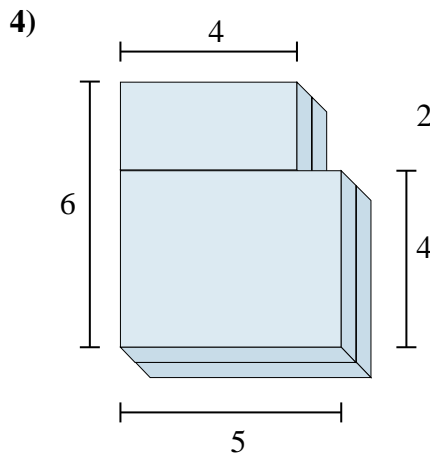
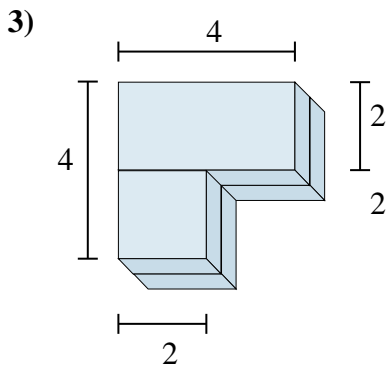
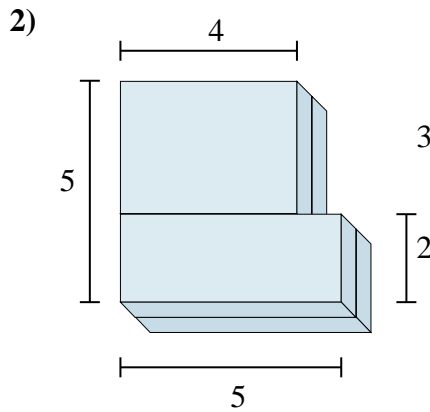
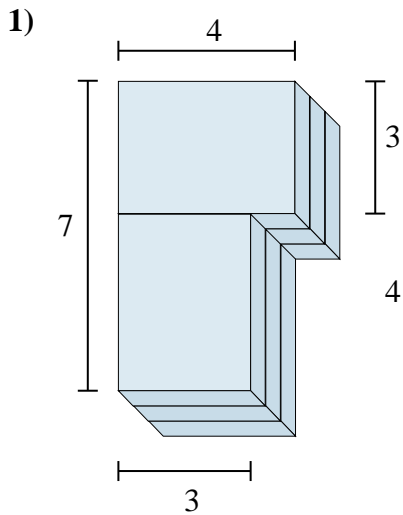

Respuestas

1. _____

2. _____

3. _____

4. _____

5. _____

6. _____