

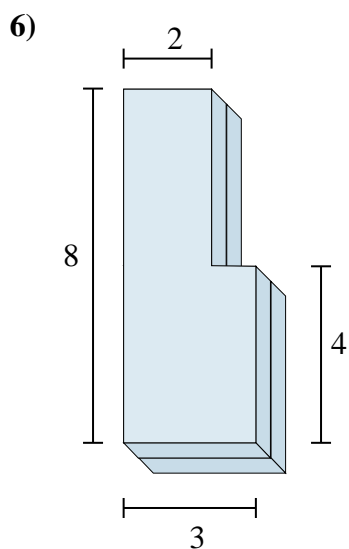

Encontrar el valor total de cada figura mostrada.

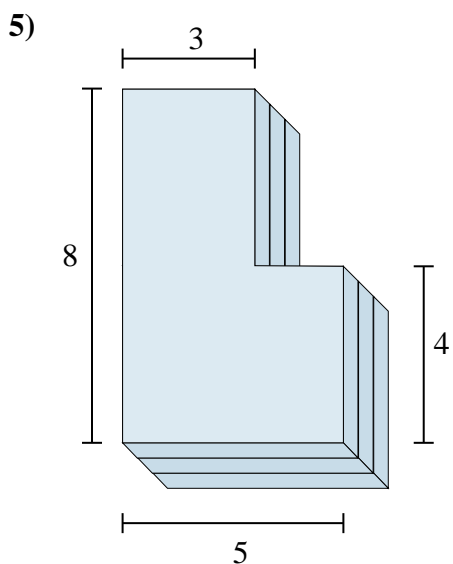
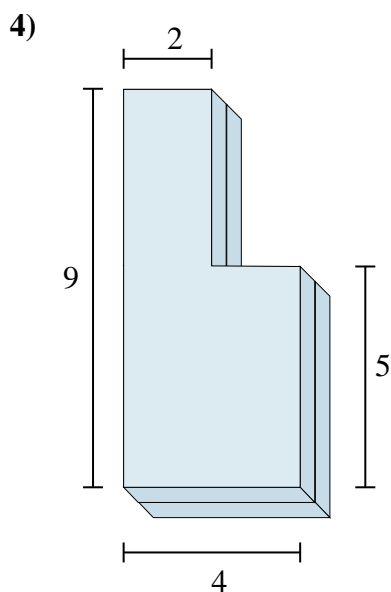
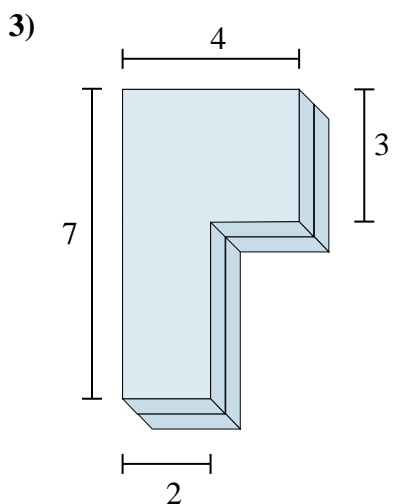
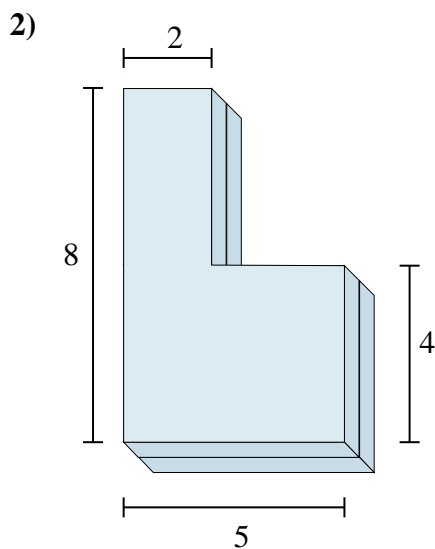
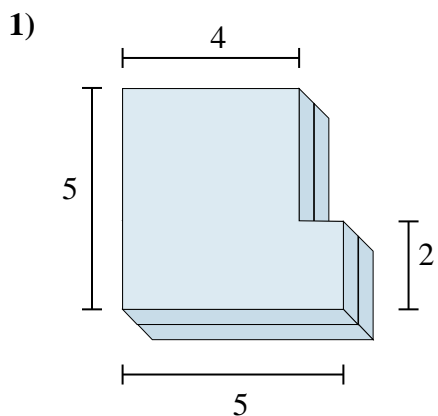

Respuestas

1. _____

2. _____

3. _____

4. _____

5. _____

6. _____



Encontrar el valor total de cada figura mostrada.

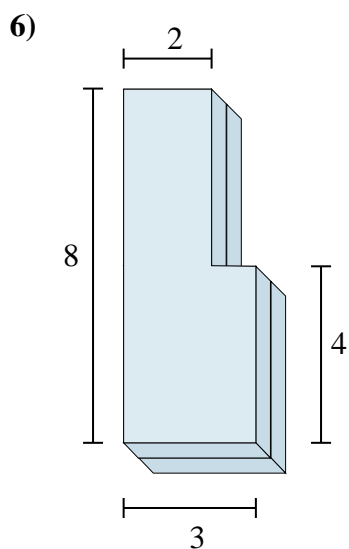
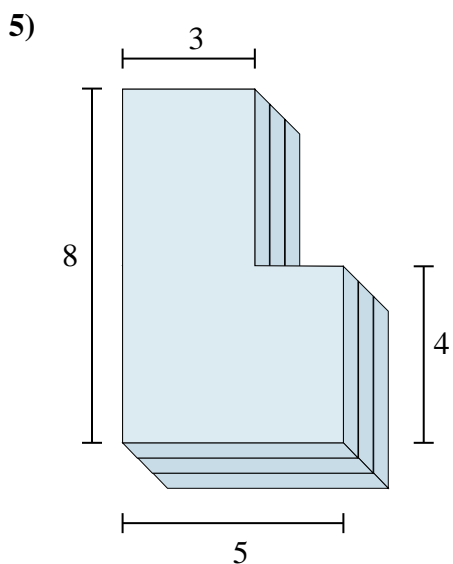
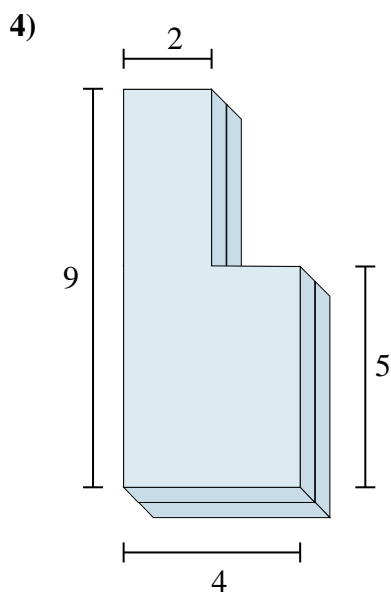
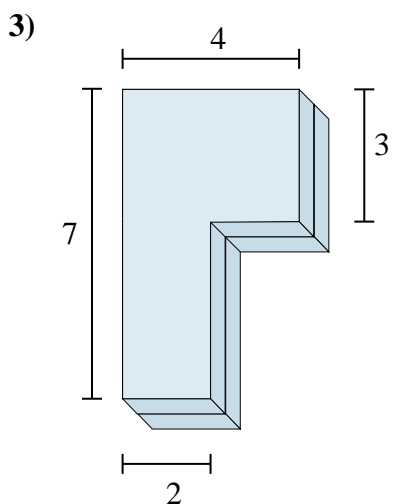
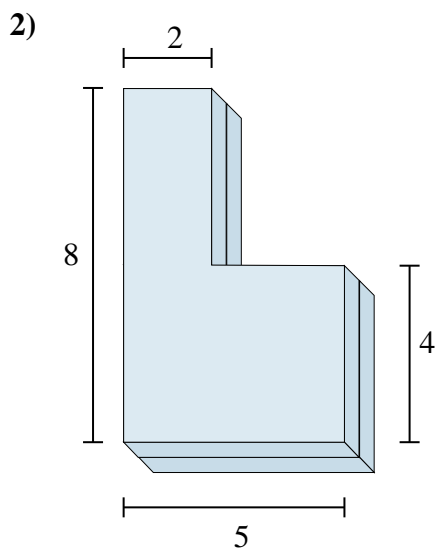
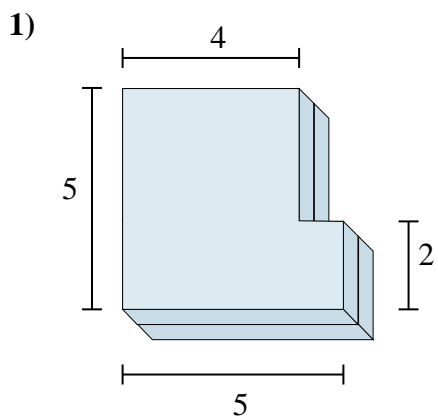

Respuestas

1. 44 cm³

2. 56 cm³

3. 40 cm³

4. 56 cm³

5. 96 cm³

6. 40 cm³



Encontrar el valor total de cada figura mostrada.

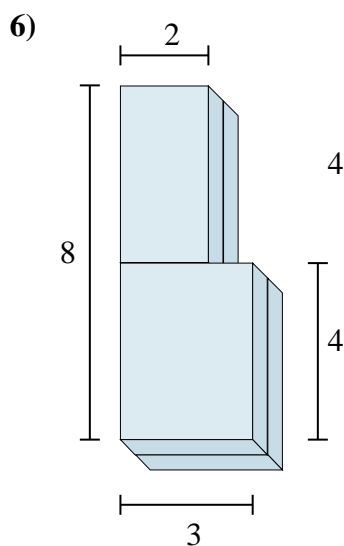
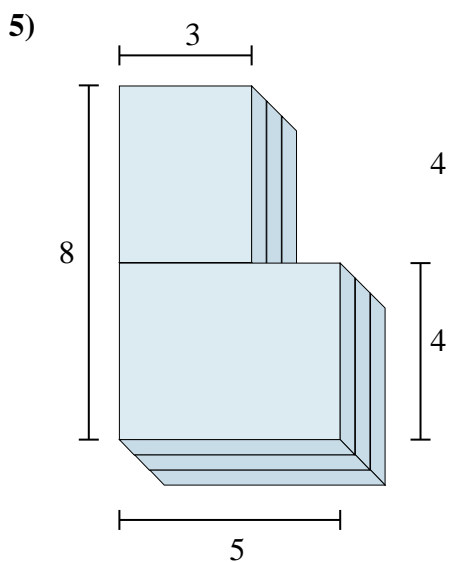
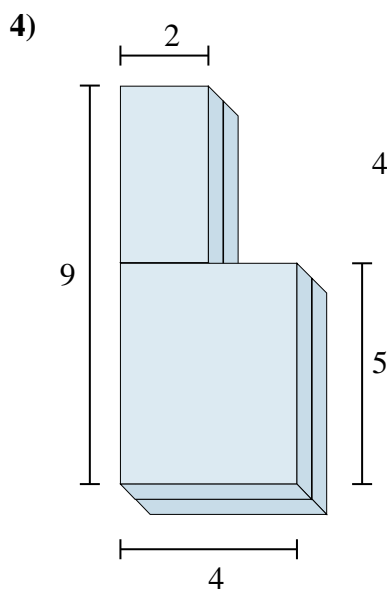
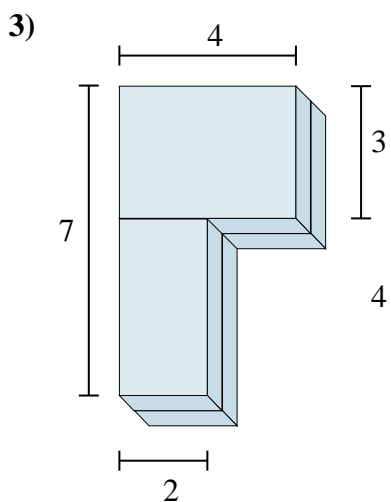
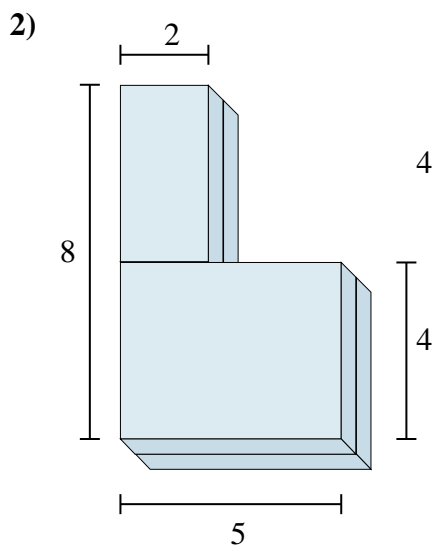
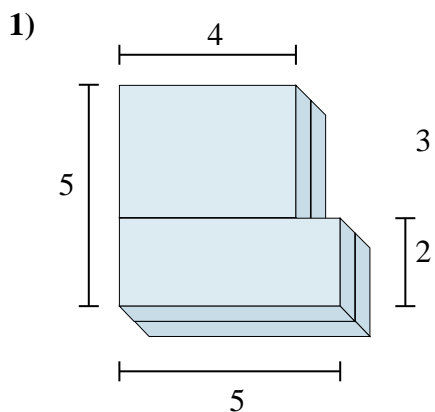

Respuestas

1. _____
2. _____
3. _____
4. _____
5. _____
6. _____