

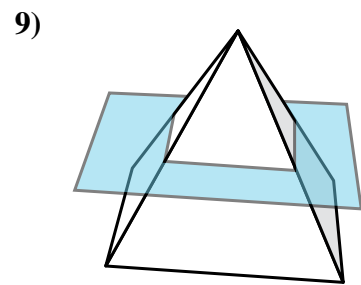

Determine la forma 2d que se crearía si la forma 3d se cortara como se muestra.

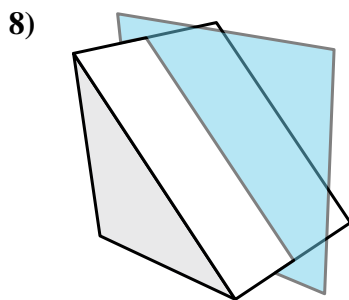

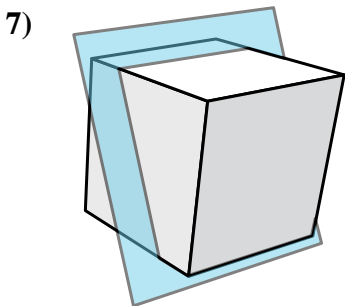
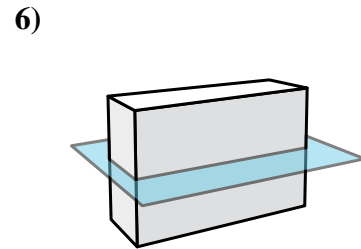
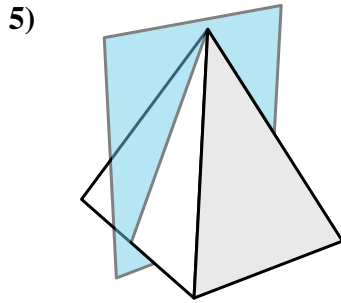
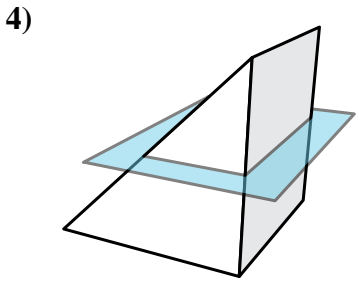
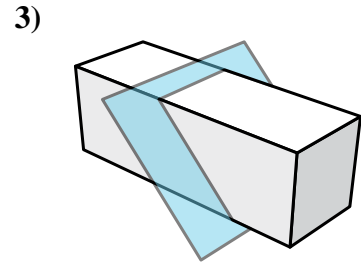
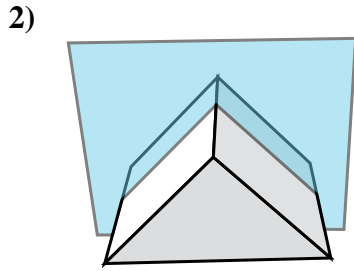
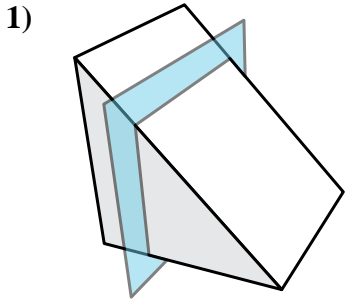

Determine la forma 2d que se crearía si la forma 3d se cortara como se muestra.

